



LED lighting as an accessory

The ideal extractor for industrial environments.

New technology in combination with new materials and a focus on design gives Movex PR many new and important advantages:

- Unique ease of maneuverability.
- High positional stability.
- Hood designed for maximum capture efficiency and extraction.

PR's design is based on Movex's basic principles:

- External arm support.
- Hose dimensions according to requirement: Ø 4, 5, 6 or 8 inches.
- Hose quality according to application.
- Supplied partially assembled for ease of installation.

PR can be equipped with LED lighting and/or switch to control fan/damper.

Movex PR is available in the lengths 5, 7, 10, 13, 16, 23, 30 and 36 feet.

The Movex range also includes fans, accessories, automatic control gear and filters for local extraction



External arm supports deliver numerous advantages

An externally positioned arm support has many advantages compared with extractors that have the supporting part internally in the extraction duct.

- Making the necessary adjustment to the friction joints is very simple.
- Option of selecting the correct hose dimension, Movex PR is available in the dimensions 4, 5, 6 and 8 inches.
- Light-weight construction with its own weight balanced by two gas springs
- In addition always has the lowest possible pressure drop.

Always choose low pressure drop

Low pressure drop always saves energy. In addition, low pressure drop produces a lower sound level, reducing the risk of disruptive ventilation noise and can more easily be combined with other extractors in the same system.

Movex PR with external arm supports and joints delivers flexibility and advantages.

The external link joints enable hose dimensions of 4, 5, 6 and 8 inches, and also make adjustment of the joints simple and relatively clean.

Compared with extractors with internal link systems, the PR arm has approx. 50% lower pressure drop.

Movex PR

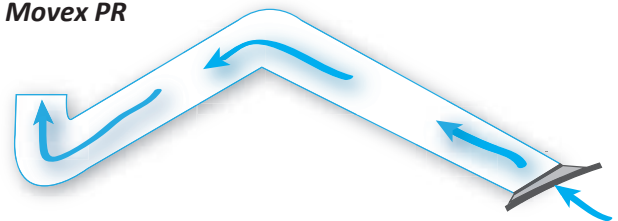

Extractors with link joints internally in the suction duct have limitations and disadvantages

Their size restricts the link joint's hose dimensions to 6" as the smallest possible selection, moreover, the location makes the necessary adjustment of the joints both difficult and often dirty.

There is up to double the pressure drop compared with Movex PR.

Internal arm support

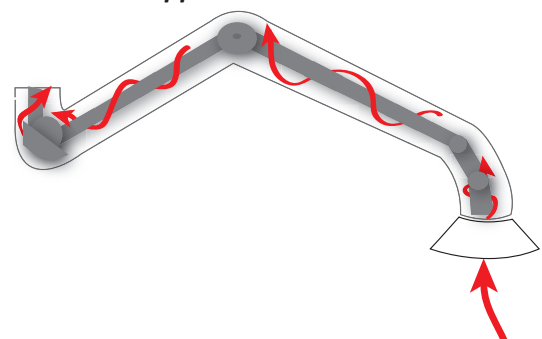

A range of designs for different needs



PR STANDARD

Brackets in powder coated steel. Arm supports in anodized aluminum and joints in anthracite grey PA & PP. Hood designed in accordance with EU standard. Injection molded in anthracite grey PP with hood plate in anodized aluminum. Hose of dark-blue PE-coated polyamide fabric.



PR WHITE

White brackets in powder coated steel. Arm supports in anodized aluminum and joints in white PA & PP. White dome with anthracite grey handle, injection molded in PP with dome plate in anodized aluminum. Hose in white PVC.



PR RF

White brackets in powder coated steel. Arm supports in anodized aluminum and joints in white PA & PP. White hood with anthracite grey handle in injection molded PP, stainless hood plate and screws. Attachments in contact with the evacuated air made from corrosion-resistant material. Hose of white PE-coated polyamide fabric. Used for evacuating corrosive gases.



The PR arm is also available in an ATEX version, see separate product sheet.

Flow & Pressure Drop Diagram

The black line indicates the pressure drop for the arm in the same position as in the sketch. Recommended transport velocity for welding fumes is 3543 ft/m. (See blue lines for each dimension.)

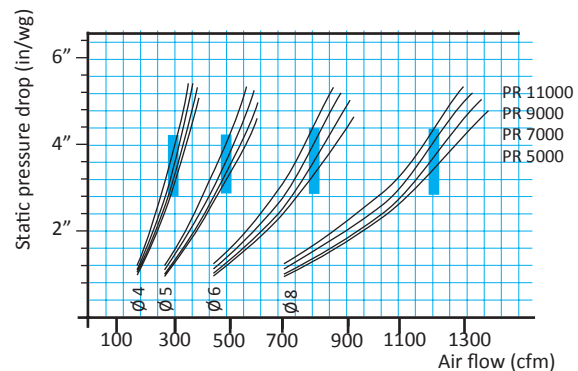
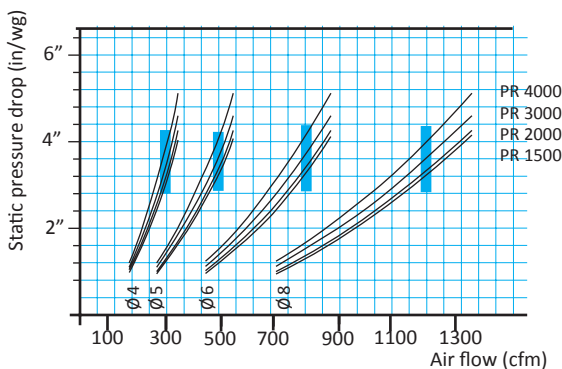
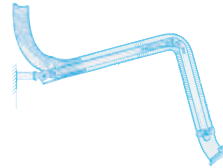

Optimally designed hood

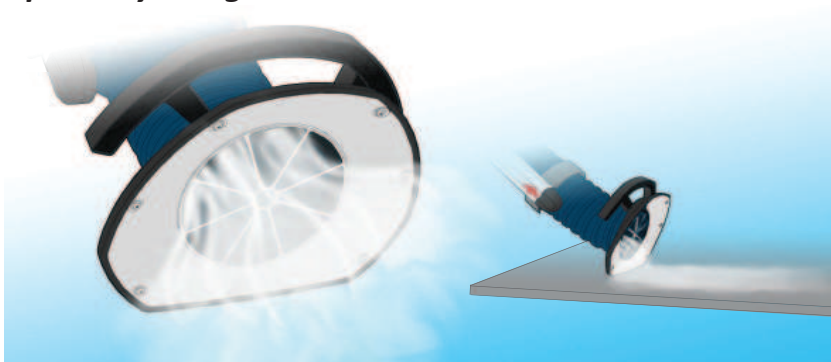

The hood is designed for maximum capture efficiency. It is ideal for capture of welding fumes and other hot contaminants. Capture efficiency for isothermal (non-hot) contaminants can be further improved by using the Coanda effect, which means that the air stream follows a level, solid surface, e.g. a table or a bench, rather than flowing freely through the room.

**PR 1500,
2000 & 3000**

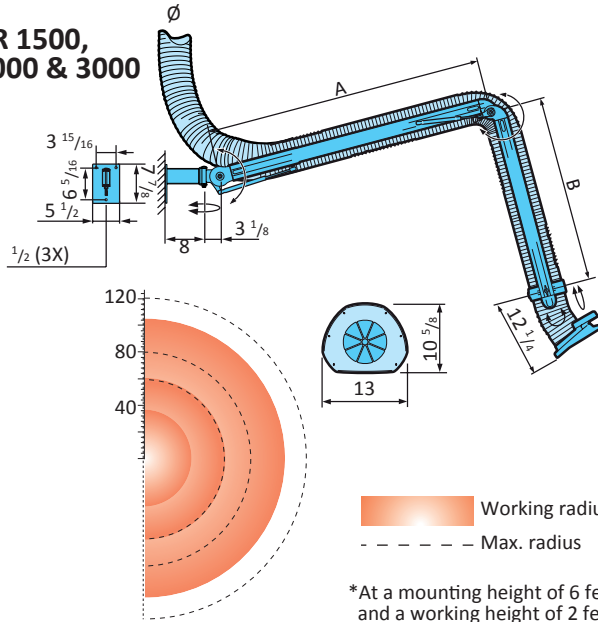

	A (inch)	B (inch)	Working radius* (inch)	Max. radius (inch)
PR 1500	16 1/2	19	36*	60
PR 2000	37 1/2	19	57**	80
PR 3000	57	39	106**	120

*At a mounting height of 6 feet,
and a working height of 2 feet, 6 inches.
**At a mounting height of 7 feet
and a working height of 2 feet, 6 inches.

PR 4000

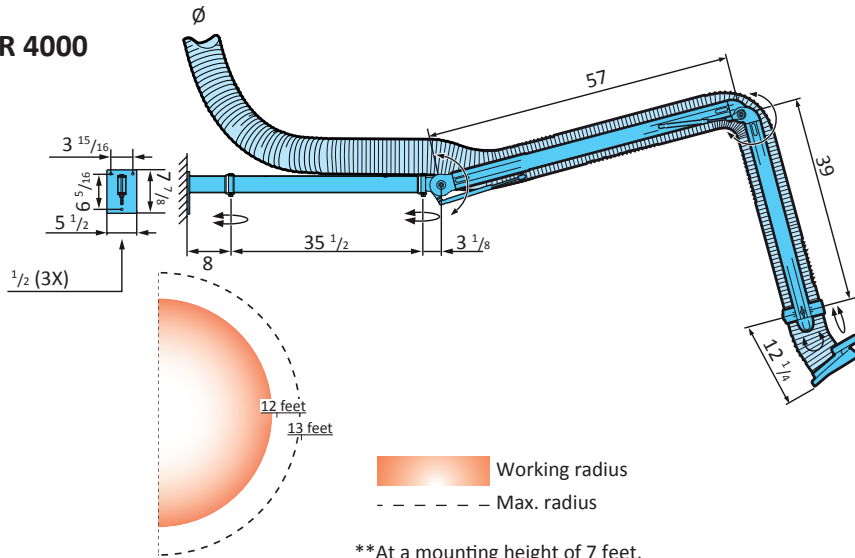

**At a mounting height of 7 feet,
and a working height of 2 feet, 6 inches.

PR 5000

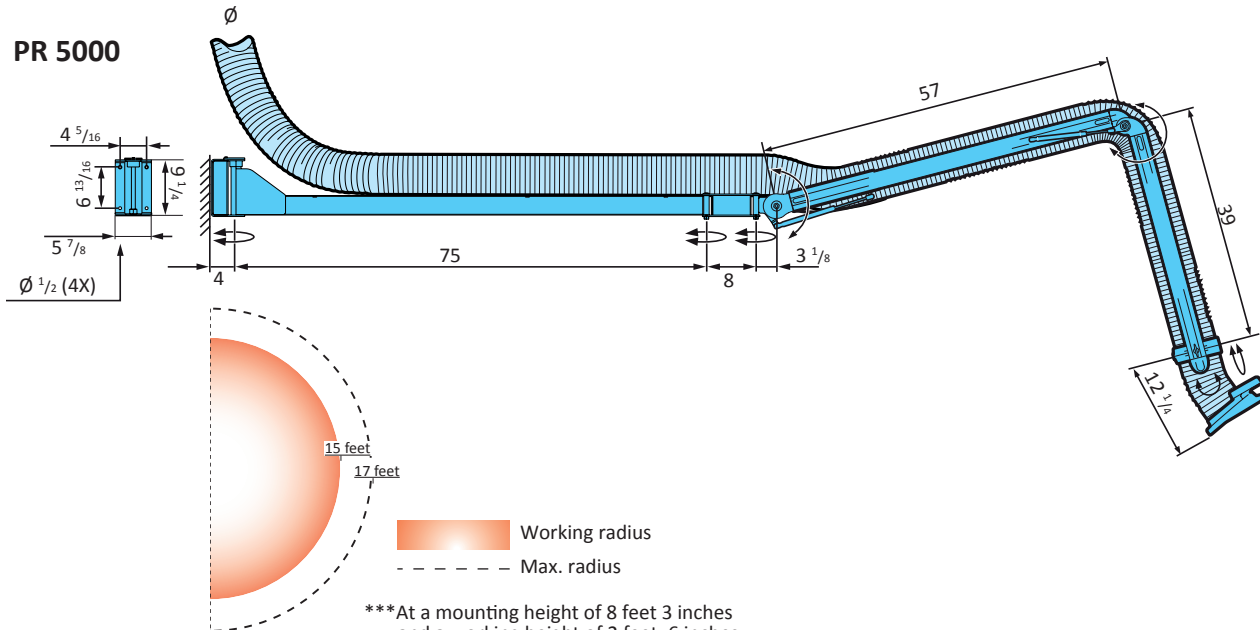

***At a mounting height of 8 feet 3 inches
and a working height of 2 feet, 6 inches.

PR 7000

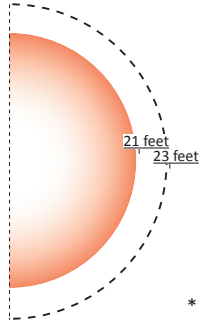
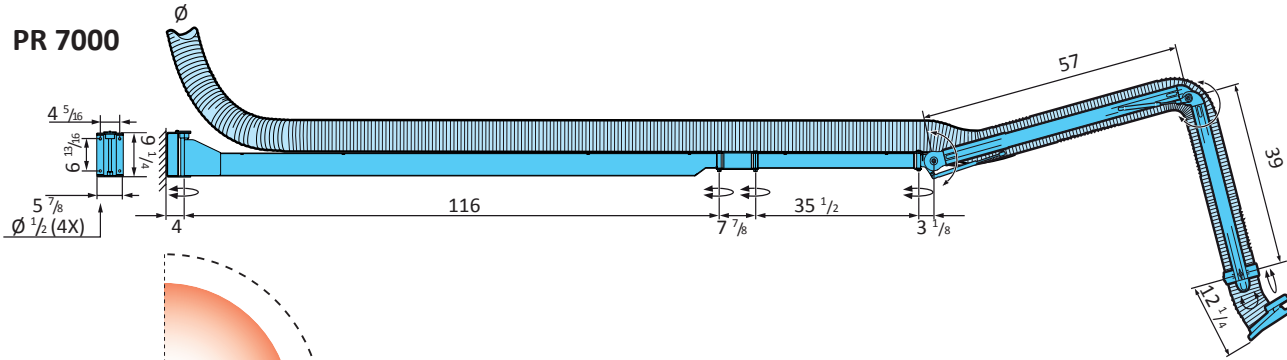

Working radius
Max. radius

***At a mounting height of 8 feet 3 inches and a working height of 2 feet, 6 inches.

PR 9000

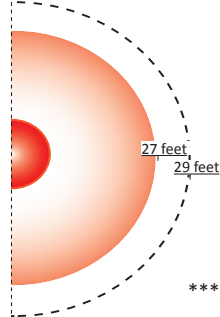
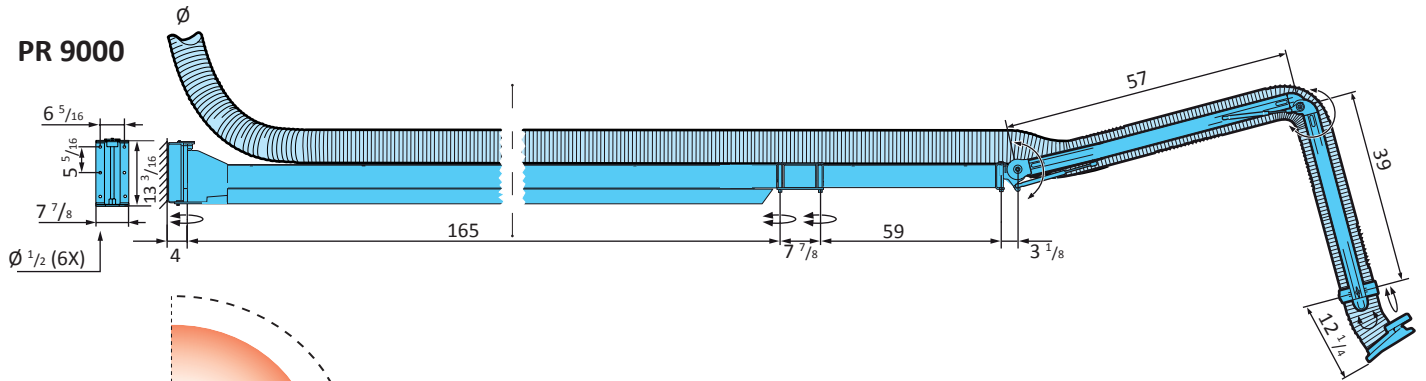

Working radius
Non-working area
Max. radius

***At a mounting height of 8 feet 3 inches and a working height of 2 feet, 6 inches.

PR 11000

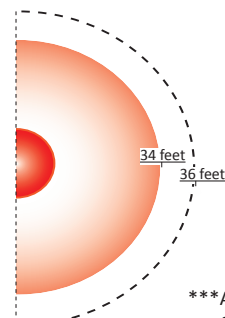
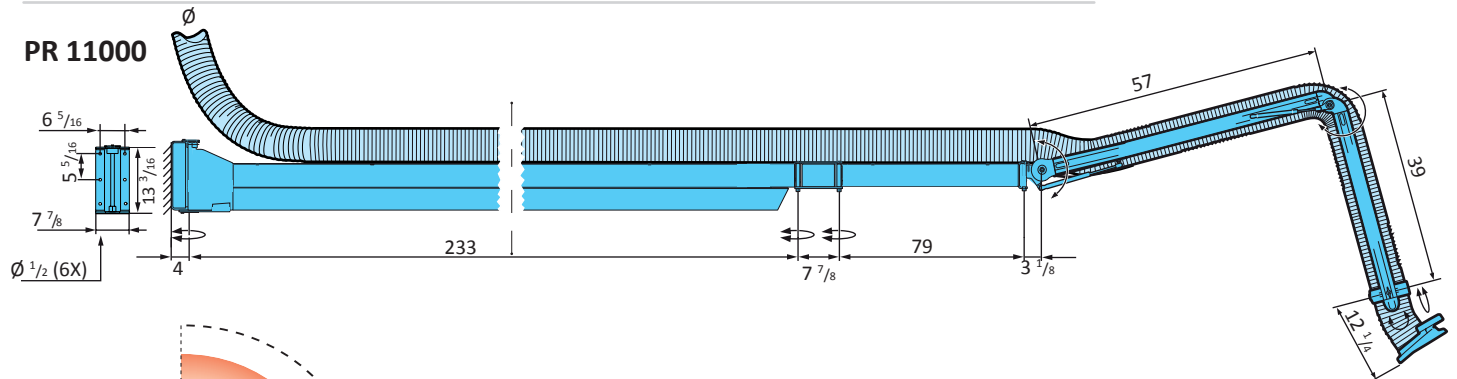

Working radius
Non-working area
Max. radius

***At a mounting height of 8 feet 3 inches and a working height of 2 feet, 6 inches.

*Accessories***Brackets for ceiling-, floor- and column mounting.**

Movex PR is supplied as standard including wall bracket. The following brackets are available for ceiling- and floor mounting.

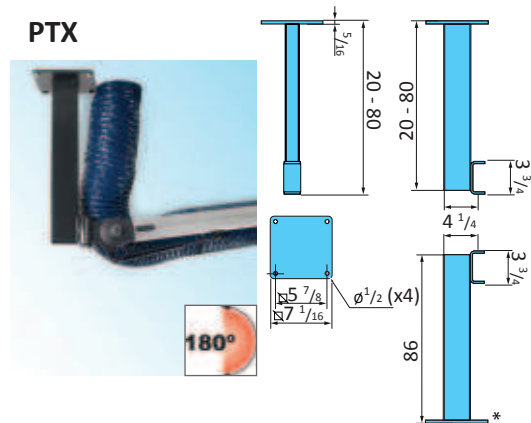

Ceiling- and floor bracket for extractor type Movex PR in lengths 5, 7, 10 & 13 feet. Rotatable 180°.

PTX Article	Length	Weight (lb)
PTX 500	20"	11
PTX 1000	40"	17
PTX 1500	60"	22
PTX 2000	80"	28
PTX 2200*	86"	31

*Floor bracket

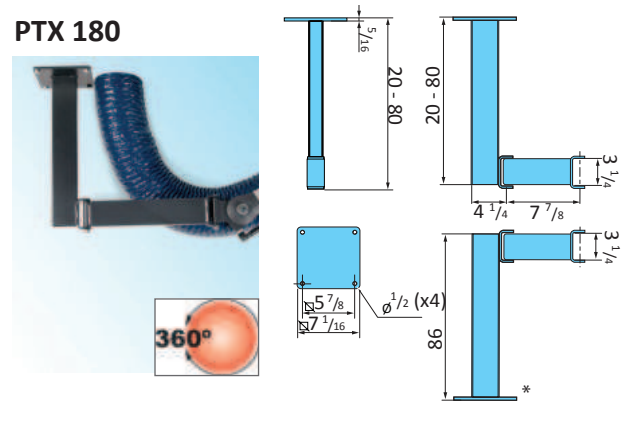

Ceiling- and floor bracket for extractor type Movex PR in lengths 5, 7, 10 & 13 feet. Rotatable 360°.

PTX 180 Article	Length	Weight (lb)
PTX 180 500	20"	15
PTX 180 1000	40"	21
PTX 180 1500	60"	26
PTX 180 2000	80"	32
PTX 180 2200*	86"	34

*Floor bracket

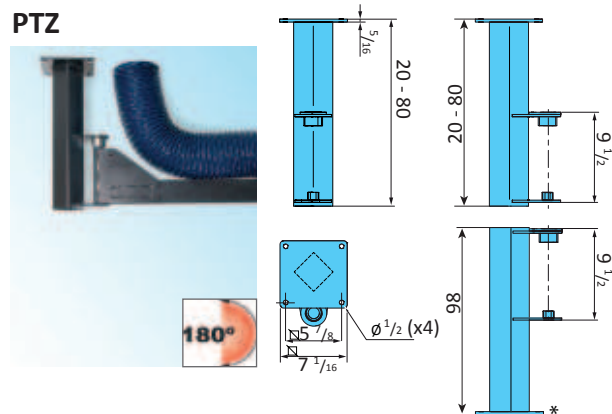

Ceiling- and floor bracket for extractor type Movex PR in lengths 16 and 23 feet. Rotatable 180°.

PTZ Article	Length	Weight (lb)
PTZ 500	20"	17
PTZ 1000	40"	26
PTZ 1500	60"	37
PTZ 2000	80"	47
PTZ 2500*	98"	57

*Floor bracket

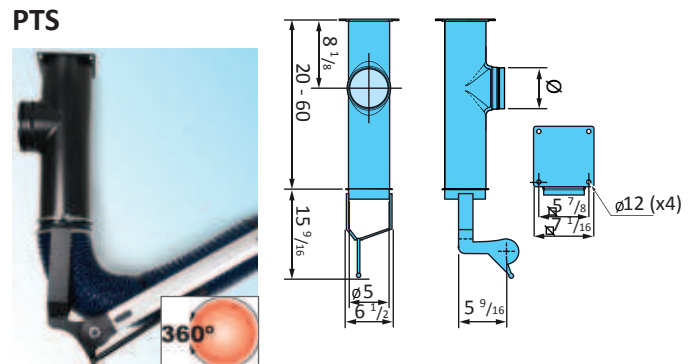

Ceiling bracket for extractor type Movex PR in lengths 5, 7 and 10 feet. Rotatable 360°, Ø5 and Ø6 inches.

PTS Article	Length	Ø (inch)	Weight (lb)
PTS 500-125	20"	Ø5	15
PTS 1000-125	40"	Ø5	18
PTS 1500-125	60"	Ø5	21
PTS 500-160	20"	Ø6	17
PTS 1000-160	40"	Ø6	21
PTS 1500-160	60"	Ø6	26

Accessories

Work lighting and fan control.

Movex PR can be supplied with work lighting and a push button for fan and damper control.



PR LED

LED work lighting including cabling, transformer and push button.



PR T

Push button for control of fan or damper.



PR LED/T

LED work lighting including cabling and transformer with push button and an additional push button for control of fan/damper.

Technical data lighting

Output.....	5 W at 350 mA
Illuminance.....	2000 lx
Colour temperature...	6500 K

Friction brake

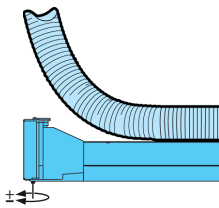

A friction brake can be mounted on the longer arms 17, 23, 30 and 36 feet. The brake is mounted under the wall bracket's joint, giving the arm optimum manoeuvrability and ensuring that the arm stays in the position selected. The friction brake is included as standard in PR 9000 and PR 11000 and can be ordered as an accessory for PR 5000 and PR 7000.

Article	Description	Length (inches)	Weight (lb)
PR 100-6340	Friction brake	8	0.6

Extension hose

With magnetic nozzle and quick connection adapted to the PR arm.

Hose, PVC coated polyamide fabric with fully embedded spring steel coil,
 Temperature range 14°F to 190°F
 Plastic components PA, PA 30%
 Aluminum components Anodized
 Steel components Black oxidized, chromed or powder coated

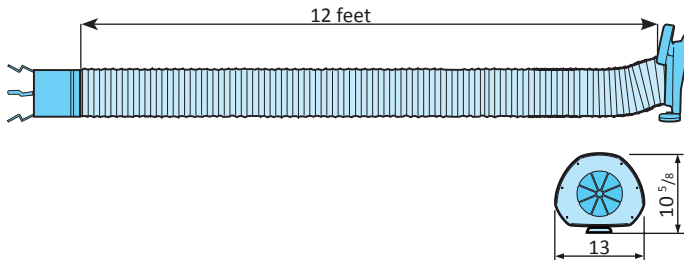

Article	Description	Ø	Length (feet)	Weight (lb)
PFS -125	Extension hose	Ø5	12	9
PFS -160	Extension hose	Ø6	12	9



Hose standard

PVC coated polyamide fabric with fully embedded spring steel coil.
 Hose in quality that cope with aggressive chemicals and other hoses with special requirements can be supplied on request, contact Movex.

Delivery configuration

The arms are supplied partially assembled, including wall bracket, for ease of installation.

Technical data hose

Properties Non-inflammable, suitable for welding fumes and flue gases.
 Temperature range 4°F to +190° F.

Technical data other standards

Plastic components PA, PA30%.
 Aluminium components Anodized.
 Steel components Black oxidized, chromed or powder coated.

Weight	PR 1500: 20 lb	PR 2000: 22 lb
	PR 3000: 26 lb	PR 4000: 33 lb
	PR 5000: 51 lb	PR 7000: 82 lb
	PR 9000: 115lb	PR 11000: 140lb

 The PR arm is also available in an ATEX version, see separate product sheet.

MOVEX®

104 Commerce Drive, Suite CNorthampton, PA 18067, USA
 Phone: 610 440-0478, Fax: 610 440-0480
 www.movexinc.com info@movexinc.com